









	400092	400068	400093	400094	400069	400079	400080	400081
								
Dimensões								
ØA	6,0	8,0	10,0	10,0	17,0	18,9	18,6	23,0

Tipo	Peça	Combinações							
A	1	101751		X			X		
	2	101917					X	X	
	3	102310	X		X				
	4	102327			X	X			
	5	500379		X				X	
	6	500380		X					X
	7	500381				X	X		
	8	500382					X		X
	9	500494	X			X			
	10	500495	X					X	
	11	500496	X						X
	12	500497				X	X		
	13	500498				X		X	
	14	500499				X			X
	15	500500		X	X				
	16	500501			X			X	



Distância entre centros (Cota C)								
Tipo A								
Rot. A	1	2	3	4	5	6	7	8
0°-180°	22,1	29,8	17,0	19,0	24,6	26,4	27,9	32,1
90°-270°	22,1	29,8	17,0	19,0	24,6	26,4	27,9	32,1
Rot. A	9	10	11	12	13	14	15	16
0°-180°	21,2	23,7	25,3	23,2	25,4	27,3	17,9	23,7
90°-270°	21,2	23,7	25,3	23,2	25,4	27,3	17,9	23,7

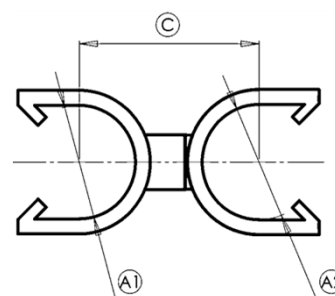
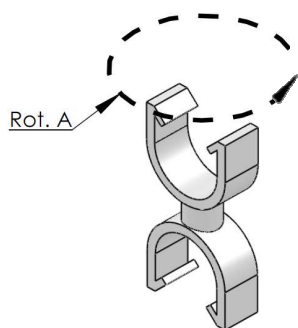
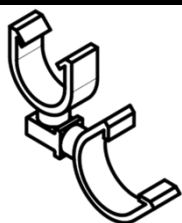

**A1**



**A2**



**A3**



**A4**



**A5**

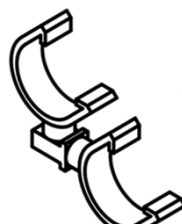

**A6**

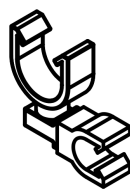



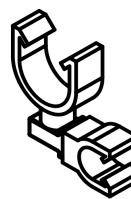

**A7**

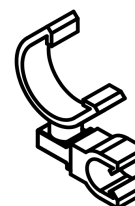

**A8**



**A9**

	400093	400069	400080	400081	400082
					
Dimensões					
ØA	10,0	17,0	18,6	23,0	-

Tipo	Peça	Combinações				
A	1 101923			X	X	X
	2 500383		X X			X
	3 500384		X	X		X
	4 500385		X		X	X
	5 500386			X X		X
	6 500387				X X	X
	7 500502	X	X			X
	8 500503	X		X		X
	9 500504	X			X	X

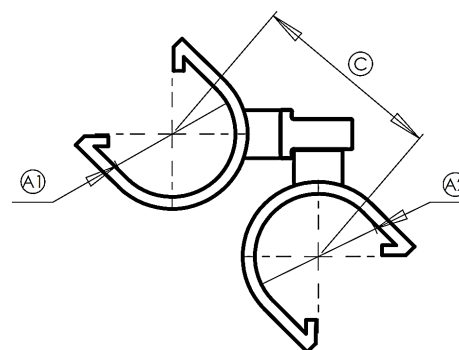
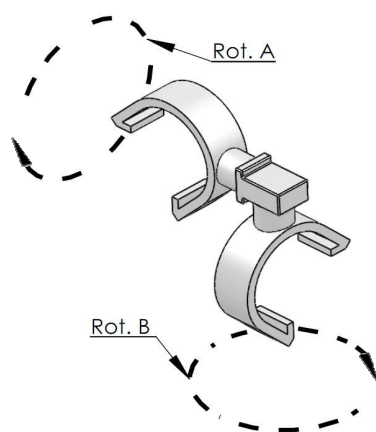

		Distância entre centros (Cota C)								
		Tipo A								
Rot. A	Rot. B	1	2	3	4	5	6	7	8	9
0°-180°	0°-180°	33,4	28,8	30,4	31,6	32,2	34,7	23,5	27,5	28,8
90°-270°	0°-180°	33,4	28,8	30,4	31,6	32,2	54,4	23,5	27,5	28,8
0°-180°	90°-270°	33,4	28,8	30,4	31,6	32,2	34,9	23,5	27,5	28,8
90°-270°	90°-270°	33,4	28,8	30,4	31,6	32,2	34,7	23,5	27,5	28,8